



**Model Number**

**V1-G-1M-PUR-V1-W**

Connection cable, M12 to M12, PUR cable, 4-pin

**Features**

- Knurled nut suitable for tool assembly
- Immunity to vibration, with mechanical latching
- Gold-plated and machined contacts
- Degree of protection IP67 / IP68 / IP69K
- Halogen-free
- Suitable for 2-, 3- and 4-wire technology

**Dimensions**

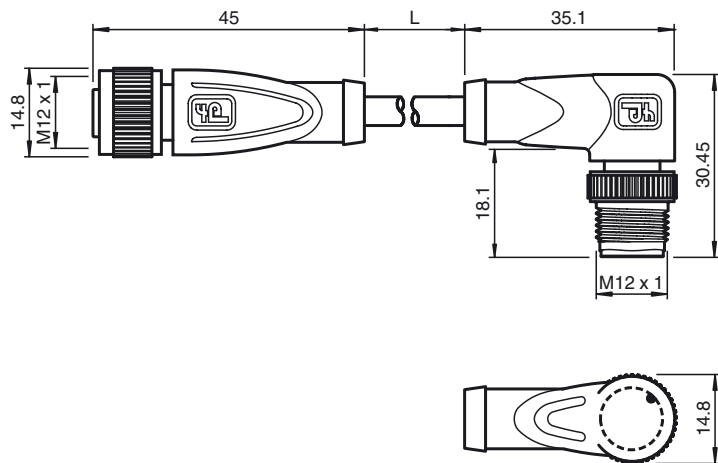

**Technical data**

**General specifications**

Number of pins	4
Connection 1	socket
Construction type 1	straight
Threading 1	M12
Connection 2	Male connector
Construction type 2	right angle
Threading 2	M12
UL File Number	E231213

**Electrical specifications**

Operating voltage	U <sub>B</sub>	max. 300 V DC
Test voltage		> 1500 V <sub>eff</sub> AC
Operating current		max. 4 A
Volume resistance		< 5 mΩ

**Ambient conditions**

Ambient temperature	-25 ... 100 °C (-13 ... 212 °F) for temperatures over 80 °C (176 °F) reduced elongation at tear
Pollution Degree	3

**Mechanical specifications**

Contact elements	spring-loaded contact socket
Pin diameter	1 mm
Degree of protection	IP67 / IP68 / IP69k
Material	
Contacts	CuSn / Au
Contact surface	Au
Body	TPU, green
Cable	PUR
Slotted nut	Diecast zinc
Sleeve connector	Diecast zinc
Core insulation	PP
Cable	fine-strand, flexible
Sheath diameter	Ø4.8 mm
Bending radius	> 10 x cable diameter, moving
Color	grey
Cores	4 x 0.34 mm <sup>2</sup>
Conductor construction	19 x 0.15 mm Ø
Length	L 1 m
Flammability	
Contact material	94 V-2
Housing	94 V-2

**Electrical connection**

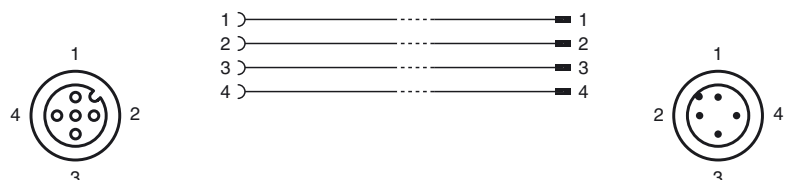

Release date: 2014-03-25 14:08 Date of issue: 2014-03-25 096745\_eng.xml